



INSTALLATION INSTRUCTIONS FOR REAR ACCESS, 265 MA T8 AND T8HLO 4 FT 4 LAMP 400 SERIES FLUORESCENT LIGHT FIXTURES FOR SPRAY PAINT BOOTH APPLICATIONS – CLEAN ROOMS

WARNING!

1. TO PREVENT THE RISK OF ELECTRICAL SHOCK DEACTIVATE/DISCONNECT THE POWER SUPPLY BEFORE INSTALLING OR RELAMPING FIXTURE.
2. THE BALLAST IN THIS FIXTURE IS DESIGNED TO OPERATE ON GROUNDED NEUTRAL SYSTEMS ONLY.
3. THIS FIXTURE SHOULD BE INSTALLED BY QUALIFIED TECHNICIANS IN STRICT ACCORDANCE WITH THE NATIONAL ELECTRICAL CODE AND ANY LOCAL REQUIREMENTS.

PAINT SPRAY BOOTH APPLICATIONS

The fixture should be sealed in such a way that only the face of the light fixture is exposed to the paint environment and the sides and rear are located in the Class I Division 2 environment.

OPERATIONAL DATA

Operate this fixture at its rated voltage. See fixture label for data. Do not install where the marked operating temperature exceeds the ignition temperature of the hazardous atmospheres.

MAINTENANCE DATA

1. Although no routine maintenance is required to keep this fixture functional, it should be checked periodically to ensure that it is working properly and to look for any external damage.
2. For optimum performance, keep light transmission parts of fixture clean. Any commercial glass cleaner can be used to clean the glass.
3. To Re-lamp: disconnect supply circuit. Remove qty 3 fasteners from rear access door opposite side from hinge. The door will swing open. Replace old lamp with new lamp. Close door and install fasteners in glass frame to seal.
4. In the event of glass breakage, it will be necessary to replace the damaged glass in order to maintain the integrity of the fixture.

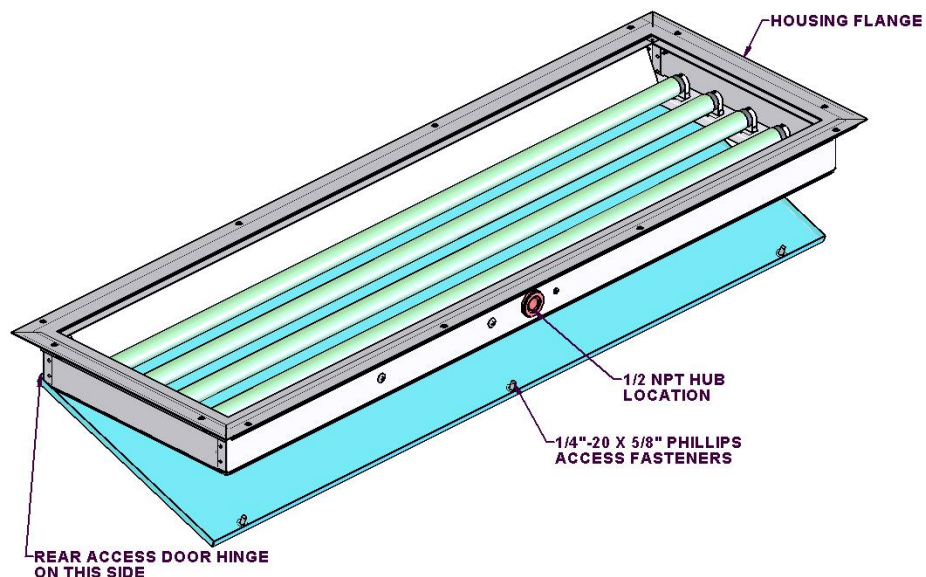

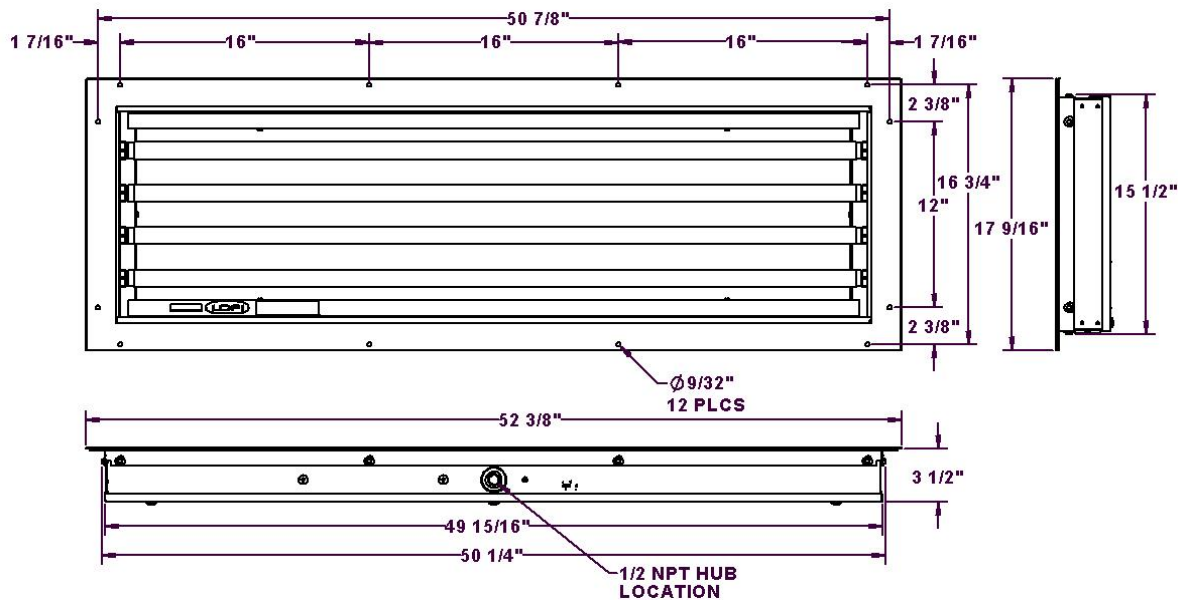

INSTALLATION

1. Mark opening on booth panel where fixture is to be located as shown per customer's applications.
2. Cut opening in booth panel using suitable tools.
3. Place light fixture into opening in booth panel, center, and mark locations of mounting holes. (4 ft. fixtures have 12 mounting holes.)
4. Remove fixture from booth panel and punch the 5/16" dia. mounting holes in panel.
5. Install light fixture into panel from inside of booth as shown. For horizontal mounting, mount with hinge on top side.

NOTE: Before installing fixture, make certain mounting gasket is installed on bottom surface of light mounting flange. Install mounting fasteners (not provided) and secure to booth panel. Customer is responsible for providing any panel reinforcements needed for mounting.

6. Caulk the flange perimeter with the same type of caulk as the spray booth.
7. Wire fixture through conduit hub according to schematic on back of ballast.
8. Remove (3) 1/4"-20 x 5/8" Phillips access fasteners, open access door, install lamps, close access door and install 1/4"-20 x 5/8" Phillips access fasteners.

NOTE: When installing lamp – fixtures are rated for 32 watts T8 lamps only.

9. Installation of light fixture onto panel is now complete.

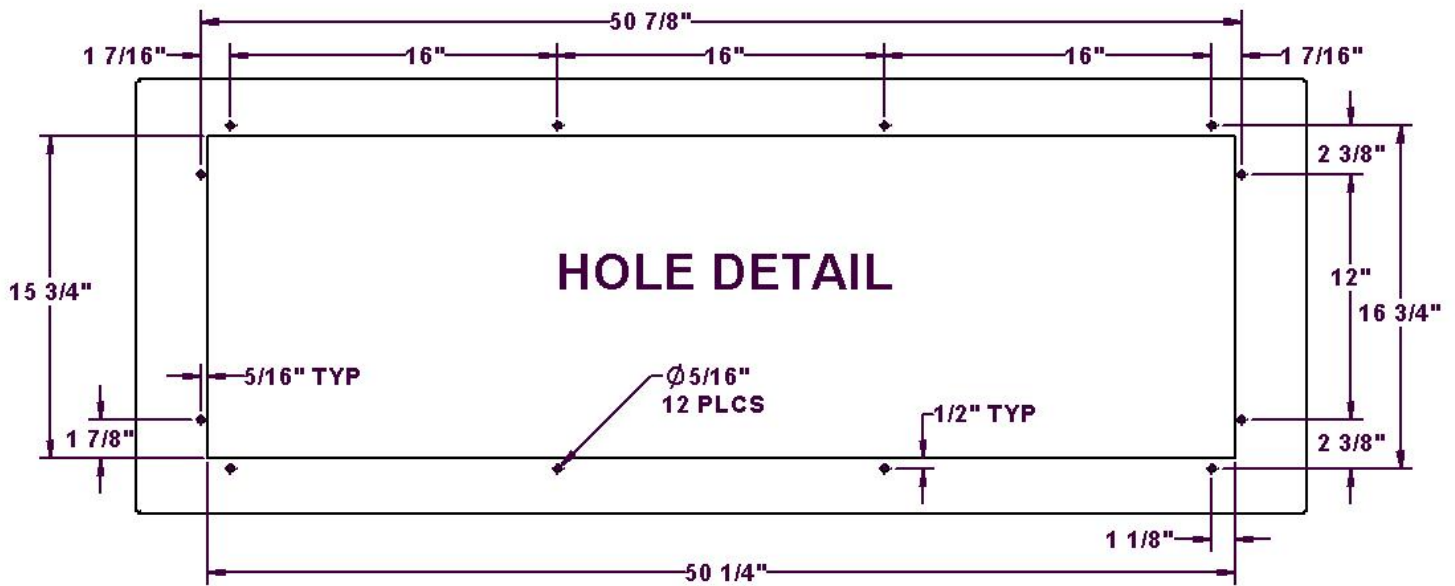

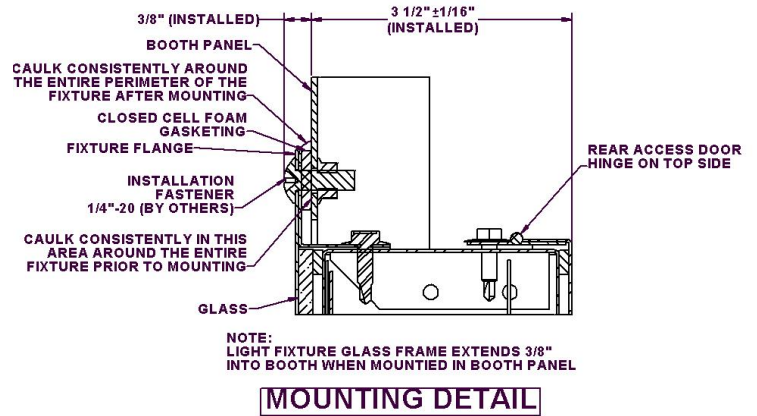
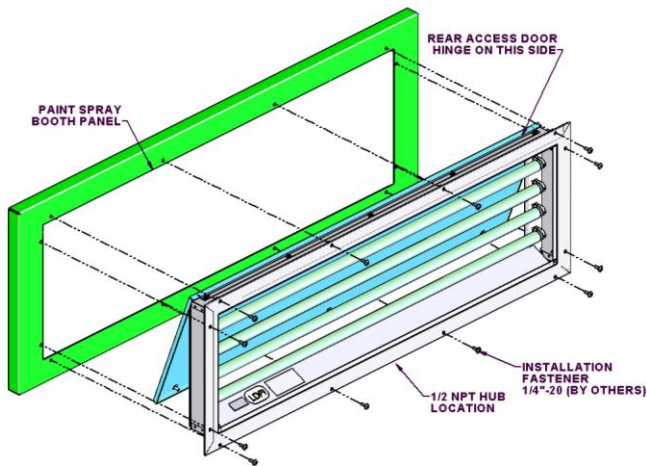

WIRING SCHEMATIC FOR:

4 FT 4 LAMP T8 AND T8HLO INSTANT START FIXTURE

32W T8 INPUT AMPS: (120V: 0.94 AMPS) (277V: 0.41 AMPS) (347V: 0.31 AMPS)

32W T8HLO INPUT AMPS: (120V: 1.23 AMPS) (277V: 0.53 AMPS)

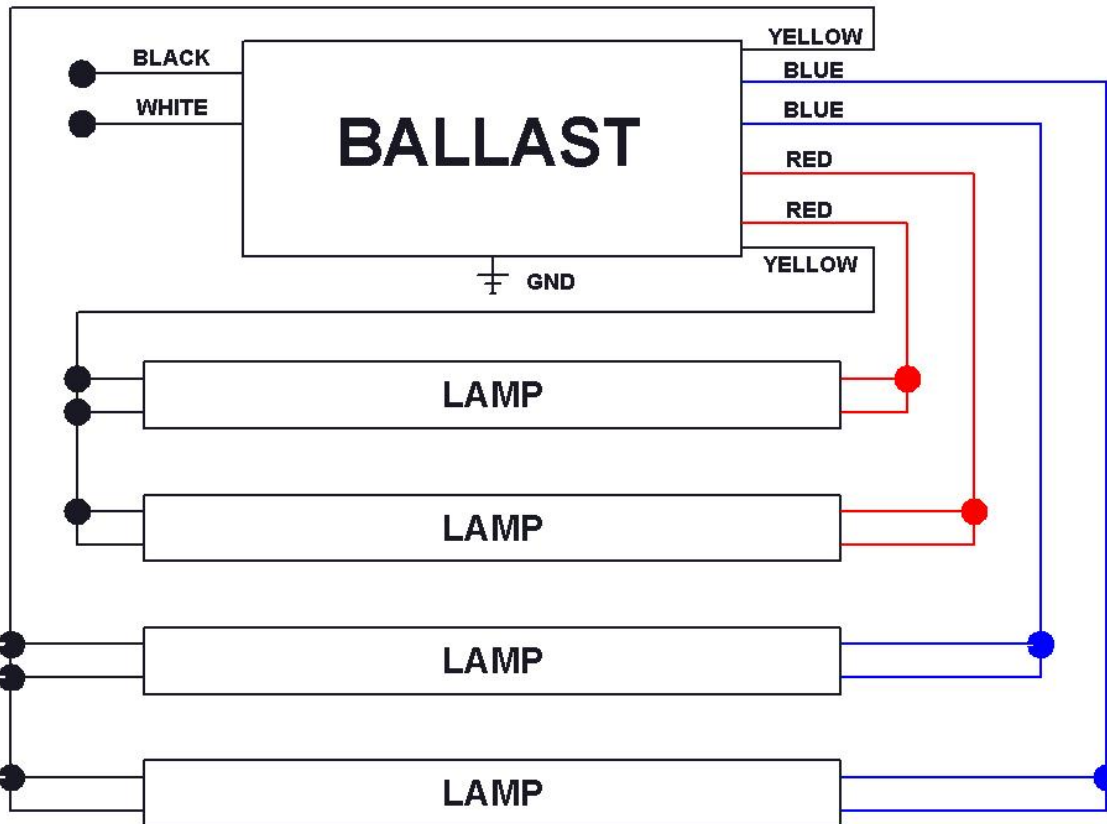

NOTE:
Refer to diagram on ballast with specific wiring details.

CAUTION:
THIS FIXTURE SHOULD BE INSTALLED BY QUALIFIED TECHNICIANS IN STRICT ACCORDANCE WITH THE NATIONAL ELECTRICAL CODE AND ANY LOCAL REQUIREMENTS