



INSTALLATION, OPERATION AND MAINTENANCE INSTRUCTIONS

LE485/LE485E LED LIGHT FIXTURE FOR SPRAY PAINT BOOTH APPLICATIONS - CLEAN ROOMS

WARNING!

1. TO PREVENT THE RISK OF ELECTRICAL SHOCK DEACTIVATE/DISCONNECT THE POWER SUPPLY BEFORE INSTALLING OR RELAMPING FIXTURE.
2. THE DRIVER IN THIS FIXTURE IS DESIGNED TO OPERATE ON GROUNDED NEUTRAL SYSTEMS ONLY.
3. THIS FIXTURE SHOULD BE INSTALLED BY QUALIFIED TECHNICIANS IN STRICT ACCORDANCE WITH THE NATIONAL ELECTRICAL CODE AND ANY LOCAL REQUIREMENTS.

PAINT SPRAY BOOTH APPLICATIONS

The fixture should be sealed in such a way that only the face of the light fixture is exposed to the paint environment and the sides and rear are located in the Class I Division 2 environment.

Since these fixtures can be accessed from inside the paint spray booth, a 2" x 3 1/2" label stating: "Caution - Do not operate paint spray equipment when fixture frame is opened. Keep the fixture frame tightly closed while paint spray equipment is operating", is included with each fixture.

OPERATIONAL DATA

Operate this fixture at its rated voltage. See fixture label for data. Do not install where the marked operating temperature exceeds the ignition temperature of the hazardous atmospheres.

INSTALLATION

1. Mark opening on booth panel where fixture is to be located as shown per customer's applications.
2. Cut opening in booth panel using suitable tools.
3. Place light fixture into opening in booth panel, center, and mark locations of mounting holes. (4 ft. fixtures have 12 mounting holes.)
4. Remove fixture from booth panel and punch the 5/16" dia. mounting holes in panel.
5. Install light fixture into panel from inside of booth as shown. For horizontal mounting, mount with hinge on top side.

NOTE: Before installing fixture, make certain mounting gasket is installed on bottom surface of light mounting flange. Install mounting fasteners (not provided) and secure to booth panel. **Customer is responsible for providing any panel reinforcements needed for mounting.**

6. Caulk the flange perimeter with the same type of caulk as the spray booth.
7. Wire fixture through conduit hub according to schematic provided below.
8. Installation of light fixture onto panel is now complete.

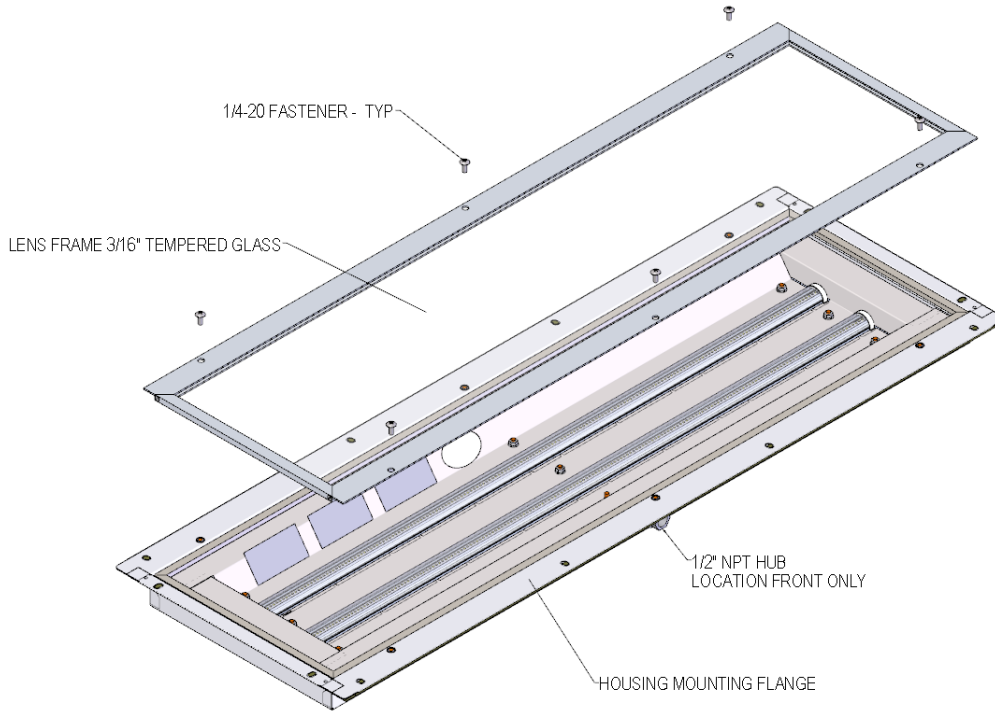

CUT OUT DIMENSIONS LE485/LE485E

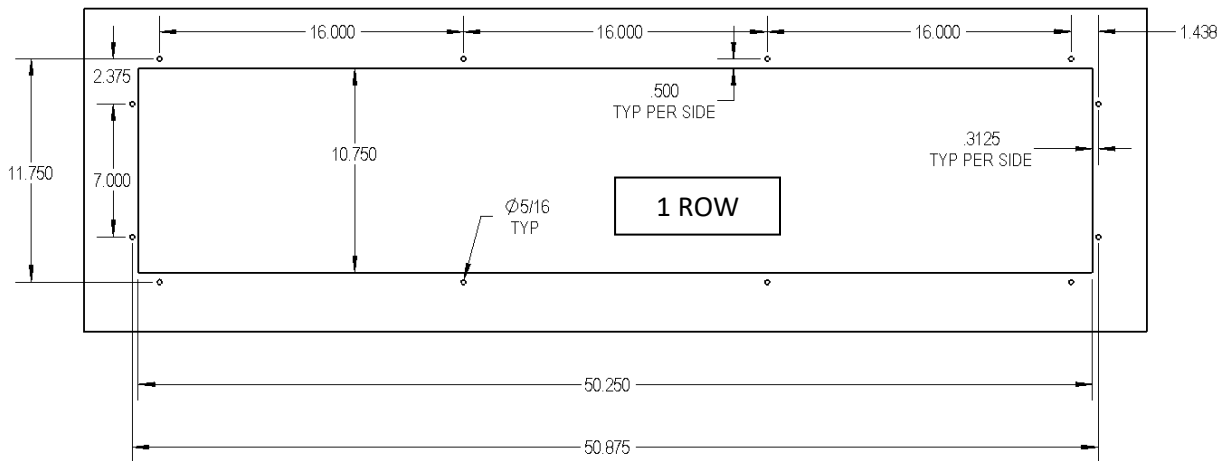

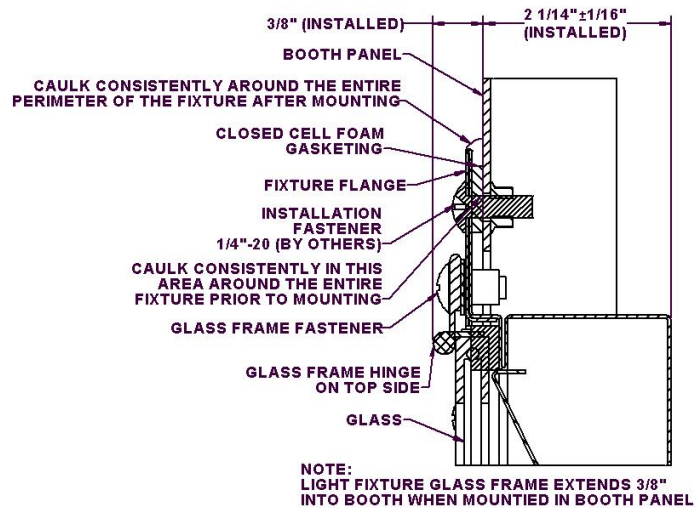
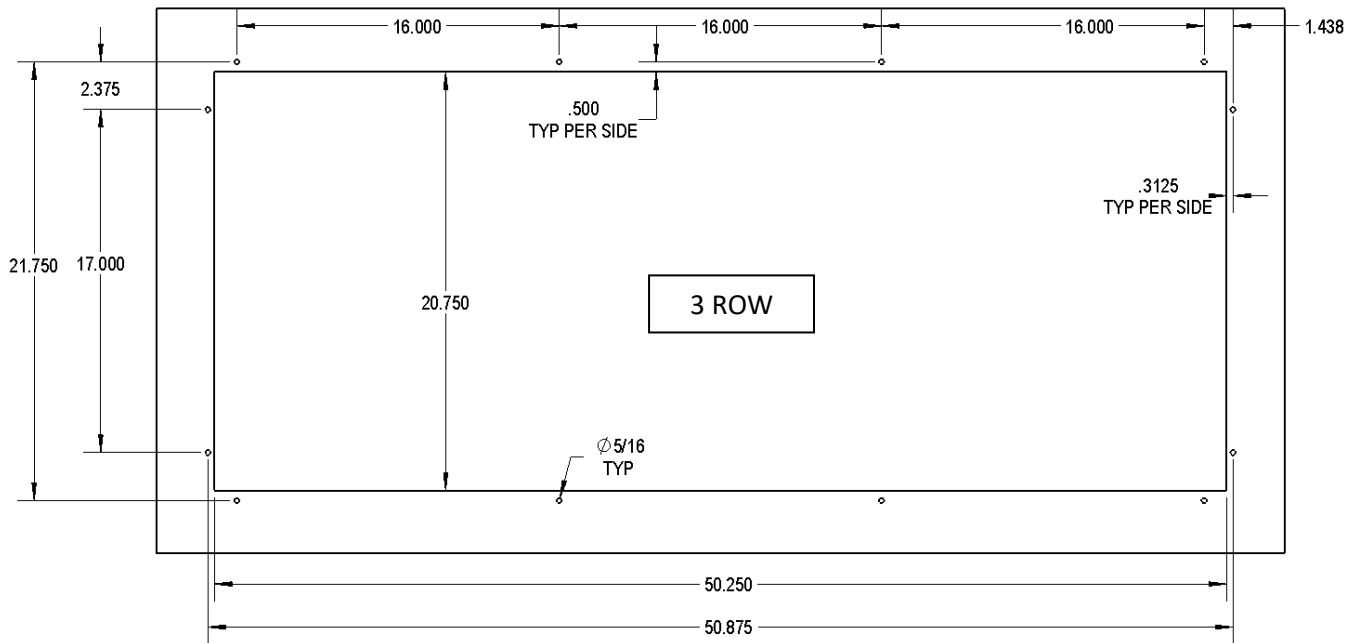
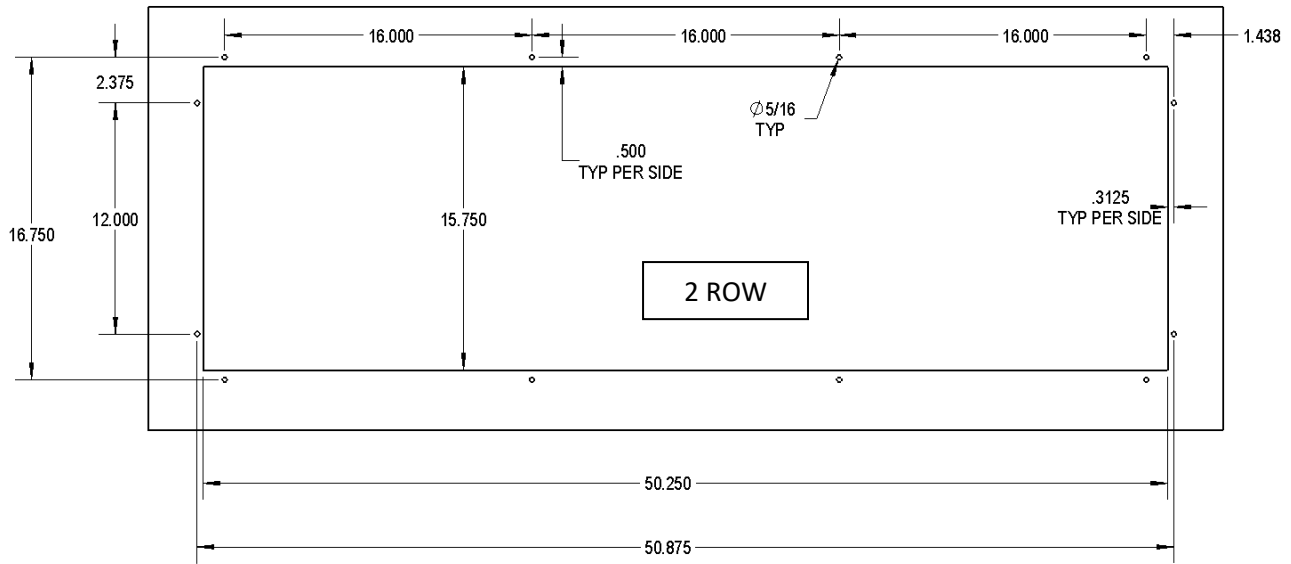

MOUNTING DETAIL

LE485

Fixture Dimensions

LE485		
SERIES	DIM "A"	DIM "B"
43/62	9 5/16"	13 1/16"
100/120	14 5/16"	18 1/16"
140/180	19 5/16"	23 1/16"

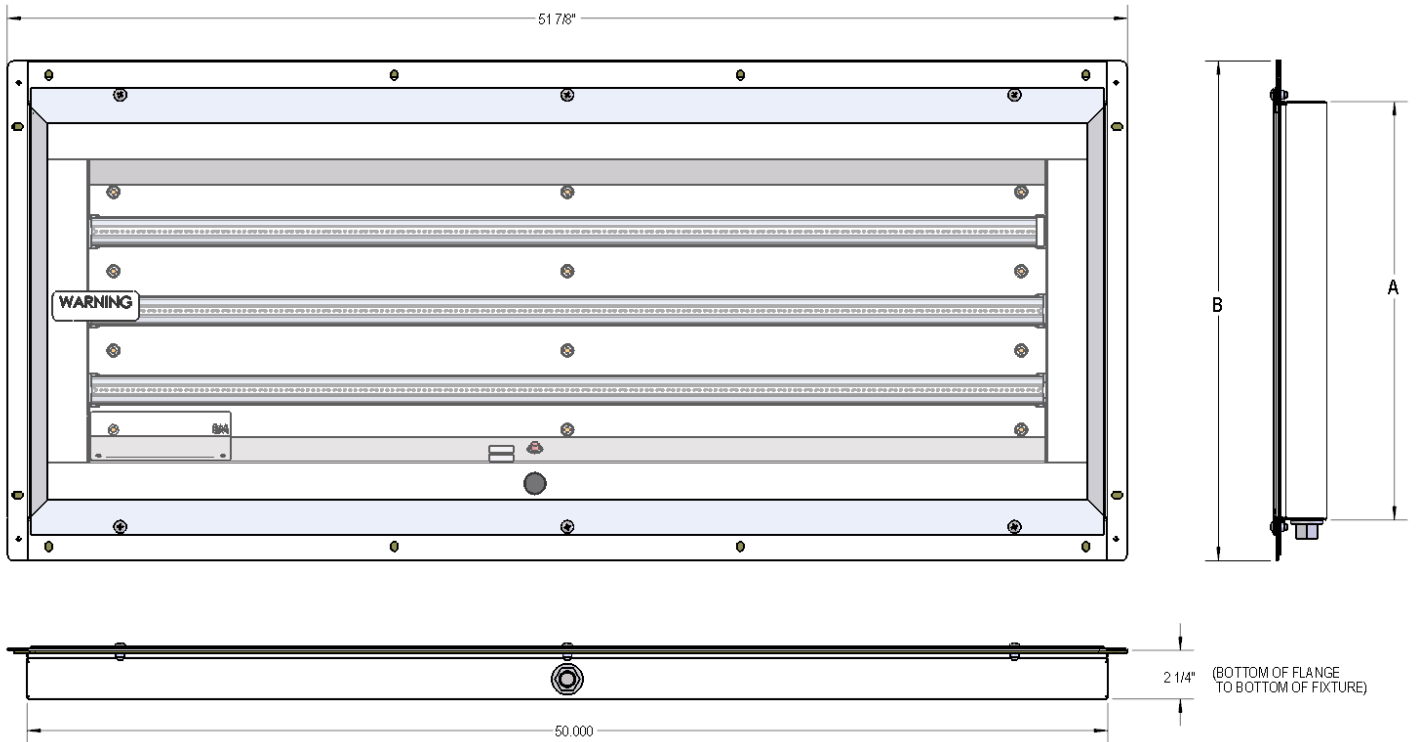

LE485E

LE485E		
SERIES	DIM "A"	DIM "B"
N1	9 5/16"	13 1/16"
W1/W2	14 5/16"	18 1/16"

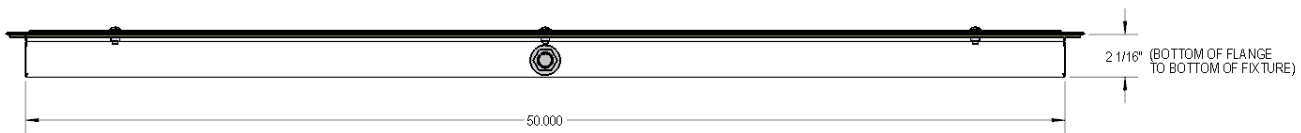
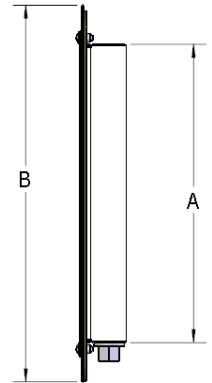
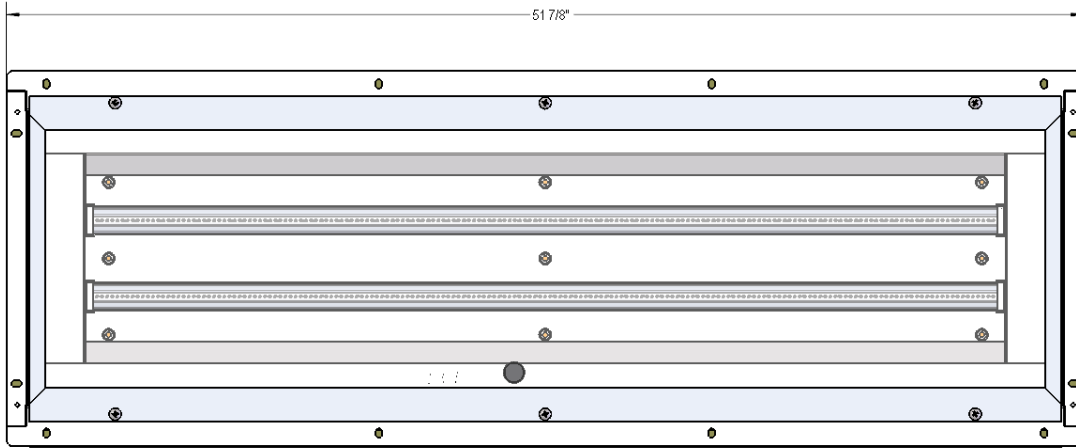

Add on options

Dimming (0-10V) - Two hubs required

5 wire whip TYP: Black: Line, White: Neutral, Green: Ground, Purple: Dim+, Grey: Dim-

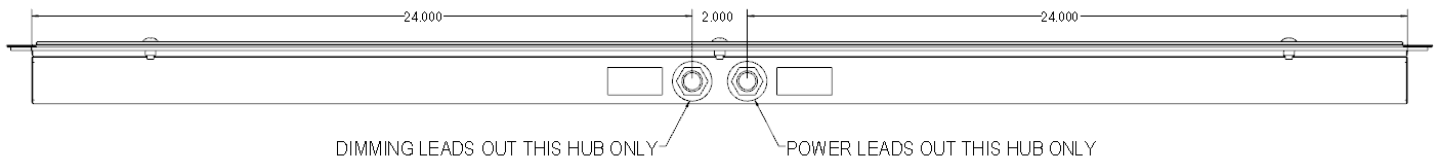

Dimming (DALI) - One hub required:

5 wire whip TYP: Black: Line, White: Neutral, Green: Ground, Purple: Dim, Grey: Dim

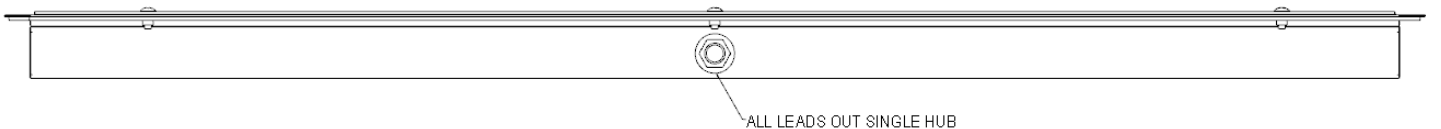

Interlock Switch:

NOTE:

Light fixtures that are equipped with an interlock switch which is a magnet switch that has normally open contacts which open when fixture is accessed from the inside of the paint spray booth. This switch is to be wired in such a way that it disables paint spray equipment when the front of the light is opened.

IMPORTANT: 10 Watt magnetic switches are not prewired. (Wiring performed by others). It may be desired by others to run separate power for this supply to segregate relay from light power. *The magnetic micro switch is **NOT** designed to directly control light operation.

NOTE:

Normally open magnetic switches are intended to be used to trigger a relay (furnished by others) which disables the paint system. Because of the small capacity of the switch a solid state relay is recommended. It may be desired by others to utilize a separate power supply to segregate the relay (furnished by others) from the lighting power supply.

The magnetic switch IS NOT designed to directly control light operation!
The magnetic switch is rated for 10 watts resistive at a maximum of 300 VAC.
Series wiring of more than 10 switches is NOT RECOMMENDED.

NOTE:

Refer to diagram on ballast with specific wiring details.

CAUTION:

Overloading the switch circuits WILL cause failure.
LDPI, Inc. recommends having a certified electrician/engineer review loads to ensure that overloading of switch does not occur.

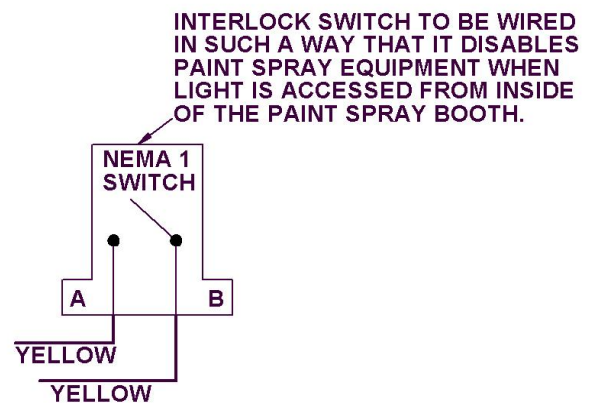

MAINTENANCE DATA

1. Although no routine maintenance is required to keep this fixture functional, it should be checked periodically to ensure that it is working properly and to look for any external damage.
2. For optimum performance, keep light transmission parts of fixture clean. Any commercial glass cleaner can be used to clean the glass.
3. In the event of glass breakage, it will be necessary to replace the damaged glass frame assembly, in order to maintain the integrity of the fixture.
4. To replace module: Disconnect supply circuit. Remove qty 6 fasteners from glass lens frame. Remove lens frame and set aside. Remove reflectors and center cover - hex flange nut 7/16" drive. The modules will be loose once the flange nuts are removed. Once the LED module is free flip it over and use a small flathead screwdriver or a like tool to depress the wire release and pull out the wires connecting the LED module. The optic and end caps from module can be re-used, or more ordered if necessary. Remove old module and dispose of properly. Install new LED module. Connect wires red to (+) blue to (-), schematic below. Flange of LED module is to be covered and held in place by the steel center cover and reflectors. Re-attach glass lens frame with 6 fasteners. Make sure all fasteners are secured tightly to ensure that the proper gasket compression is achieved.

Basic Schematics below:

****Note - Schematic - LE485E-62-W2****

****DIMMING AND INTERLOCK SWITCH LEADS ONLY PRESENT WHEN OPTIONS ARE SELECTED****

D1 (0-10v Dim) - Dimming leads are run out of fixture in separate conduit hub.

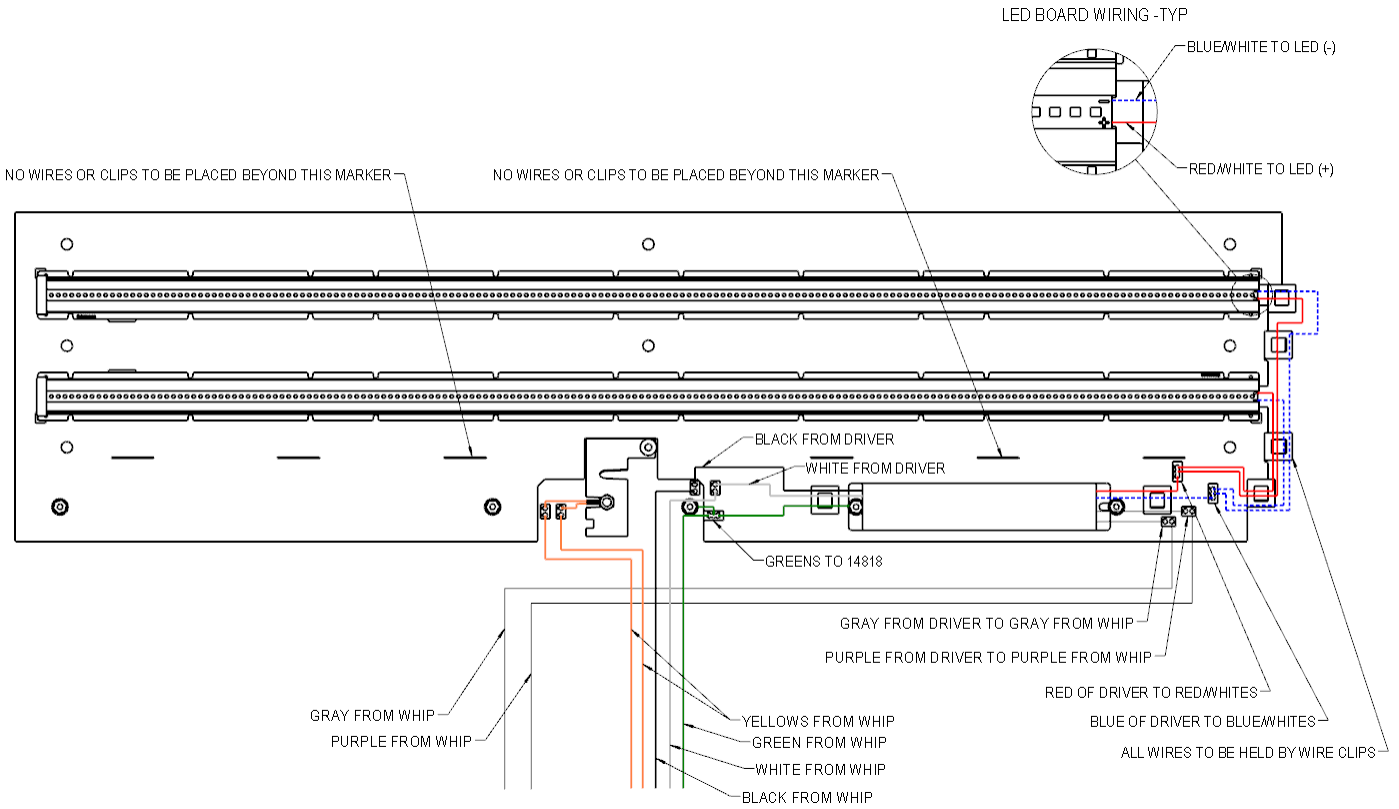

****Note - Basic Schematic - LE485-120****

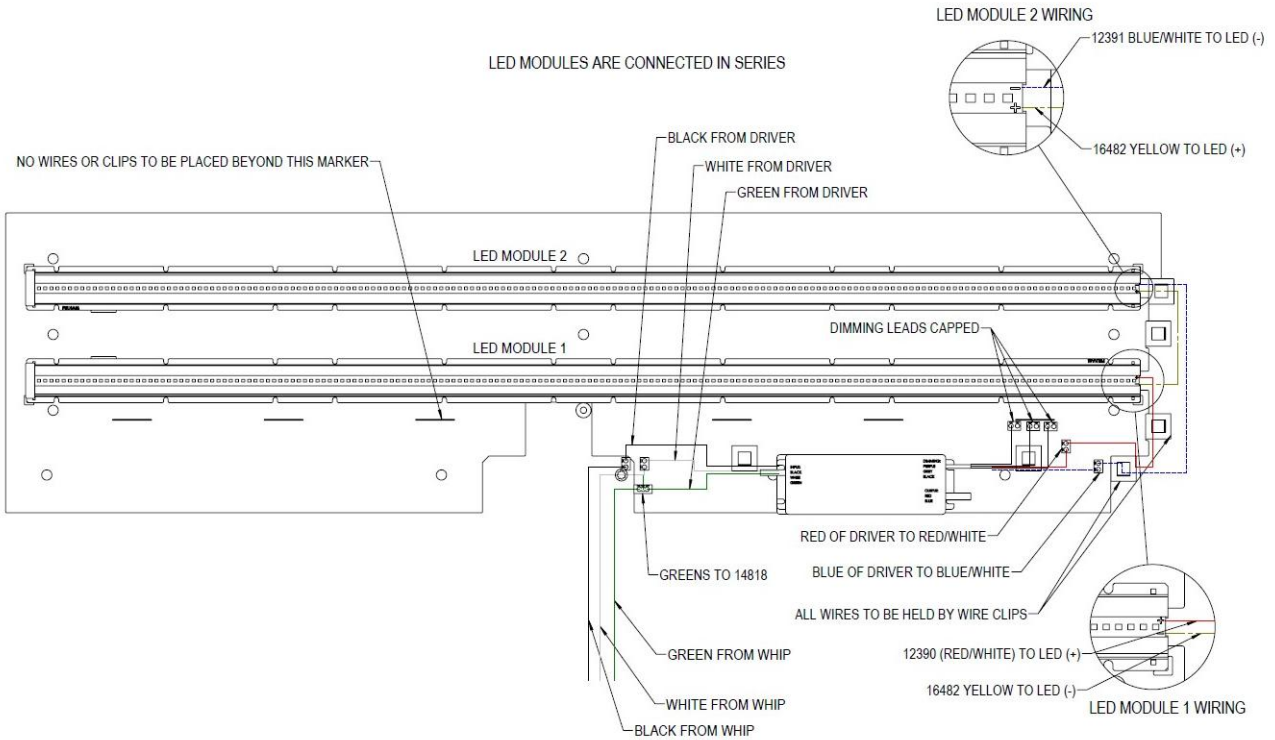

****Note - Emergency Schematic LE485-180 W/ Dimming****

"D1" (0-10V Dim) option shown - Dimming Leads run out separate conduit hub.

